



# Handy Guitar Lab for MS-60B+

for iOS

Version 1.0

## Operation Manual



This document cannot be displayed properly on black-and-white displays.

© 2024 ZOOM CORPORATION

Copying or reprinting this manual in part or in whole without permission is prohibited.

---

# Contents

---

Contents . . . . .	2
Introduction . . . . .	4
Copyrights . . . . .	4
Using with iPhones and iPads . . . . .	5
Installing Handy Guitar Lab for MS-60B+ . . . . .	5
Connecting to the MS-60B+ . . . . .	5
Handy Guitar Lab for MS-60B+ Overview . . . . .	7
Using the Effects Screen to manage effects . . . . .	8
Effects Screen Overview . . . . .	8
Deleting/Restoring Effects . . . . .	9
Sorting Effects . . . . .	10
Filtering Effects . . . . .	11
Viewing Effect Properties . . . . .	12
Using the Patch Memory Screen to manage patch memories . . . . .	13
Patch Memory Screen Overview . . . . .	13
Reordering a Patch Memory . . . . .	14
Editing Patch Memory Names and Comments . . . . .	15
Backing Up a Single Patch Memory . . . . .	16
Backing Up Multiple Patch Memories . . . . .	17
Restoring backed up patch memories to the unit . . . . .	18
Restoring a Back Up to the Device . . . . .	19
Sharing a Patch Memory . . . . .	20
Importing a Patch Memory . . . . .	21
Using the Editor Screen to edit patch memories . . . . .	22
Editor Screen Overview . . . . .	22
Selecting a Patch Memory for Editing . . . . .	23
Editing a Patch Memory Name . . . . .	24
Turning effects on/off . . . . .	25
Adjusting Effect Parameters . . . . .	26
Changing Effects . . . . .	27
Adding Effects . . . . .	28
Deleting Effects . . . . .	29
Reordering Effects . . . . .	30
Adjusting Tempo . . . . .	31
Changing the R signal output position . . . . .	32
Saving a Patch Memory . . . . .	33

Reverting a Change .....	34
Using combinations of favorite effects (clips) .....	35
■ Creating Clips .....	35
■ Adding a Clip to a Patch Memory .....	36
■ Editing Clip Names .....	37
■ Deleting a Clip .....	38
Creating a New Patch Memory .....	39
Erasing a Patch Memory .....	40
Tuning Your Instrument .....	41
Using the News Screen to review updated information .....	42
News Screen Overview .....	42
Select and View News Updates .....	43
Download Patch Memory Updates .....	44
Loading effects that are newly available into the unit .....	45

---

# Introduction

---

Handy Guitar Lab for MS-60B+ is a remote control application specifically designed for the ZOOM MS-60B+ MultiStomp. Whether you are creating and editing patch memories, managing effects and patch memories or backing up patch memories, this app allows you to operate a MS-60B+ from an iOS compatible mobile device. This manual does not explain the operation of the MS-60B+. See the MS-60B+ Operation Manual for detailed information about all its functions.

## Accessibility for the Visually Impaired

Handy Guitar Lab for MS-60B+ supports iPhone VoiceOver. With VoiceOver enabled, people with visual impairments can use the app to control the MS-60B+.

---

# Copyrights

---

iPhone, iPad, iPadOS and Lightning are trademarks of Apple Inc.

App Store is a service mark of Apple Inc.

iOS is a trademark or registered trademark of Cisco Systems, Inc. in the USA and other countries and is used under license.

USBType-C is a trademark of the USB Implementers Forum.

Product names, registered trademarks and company names in this document are the property of their respective companies. All trademarks and registered trademarks in this document are for identification purposes only and are not intended to infringe on the copyrights of their respective owners.

# Using with iPhones and iPads

## Installing Handy Guitar Lab for MS-60B+

1. Open the App Store on the iPhone and search for Handy Guitar Lab for MS-60B+.
2. Tap "GET" on the Handy Guitar Lab for MS-60B+ screen.  
This will install Handy Guitar Lab for MS-60B+ on the device.



### HINT

- This can also be installed and used on iPads.

## Connecting to the MS-60B+

1. Connect the MS-60B+ to your iPhone using a USB-C to USB-A cable and an Apple Lightning to USB 3 Camera Adapter.

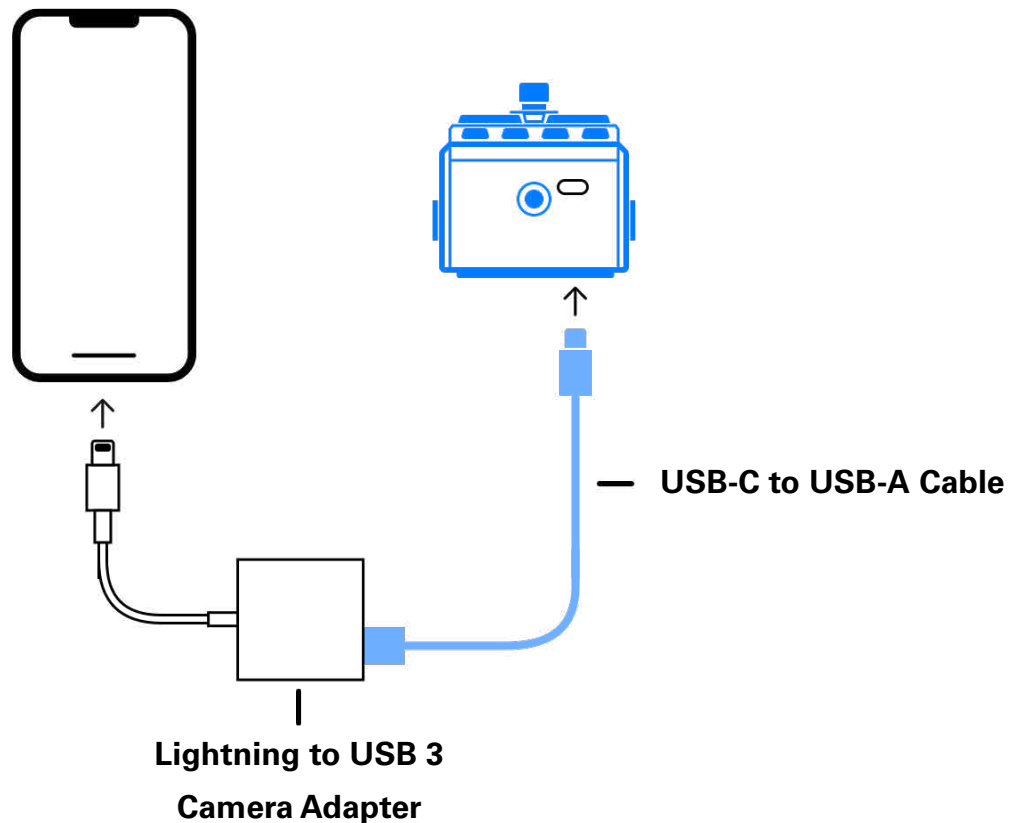

### NOTE

- Please make sure the USB cable being used supports data transfer.
- For iOS / iPadOS devices with connectors, please connect using a USB-C to USB-C cable.

**2. Turn on the MS-60B+.**

**3. Tap the Handy Guitar Lab for MS-60B+ app icon.**  
Handy Guitar Lab for MS-60B+ will launch.



**4. Tap "OK" to download the latest MS-60B+ data.**

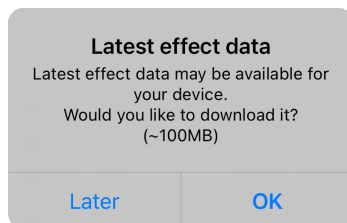

**5. The MS-60B+ and Handy Guitar Lab will sync data and connect.**

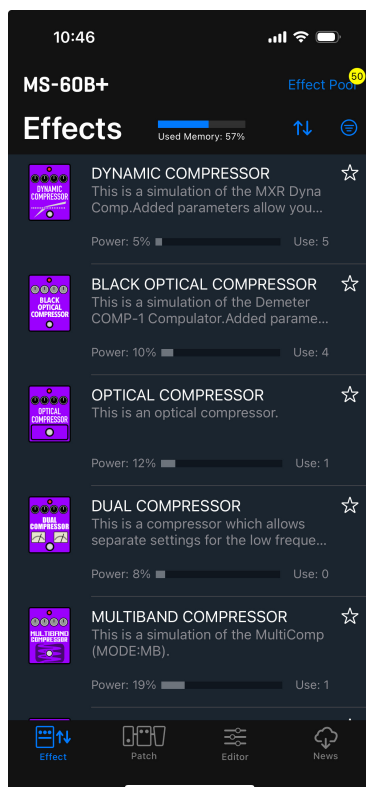

# Handy Guitar Lab for MS-60B+ Overview

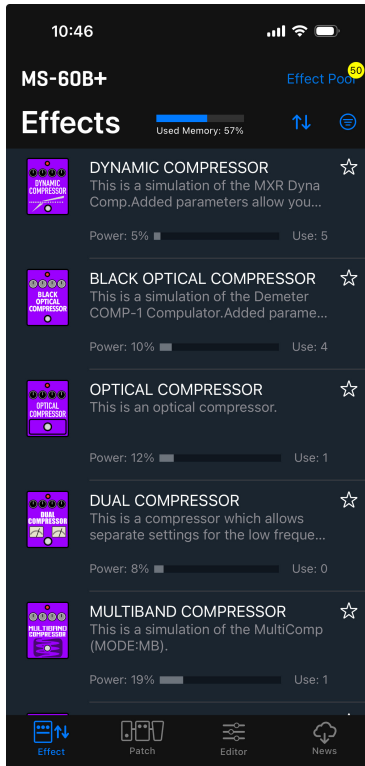

## Effects Screen

View the effects installed on the device (with sort and filter tools), add/remove them, and download new effects from ZOOM.

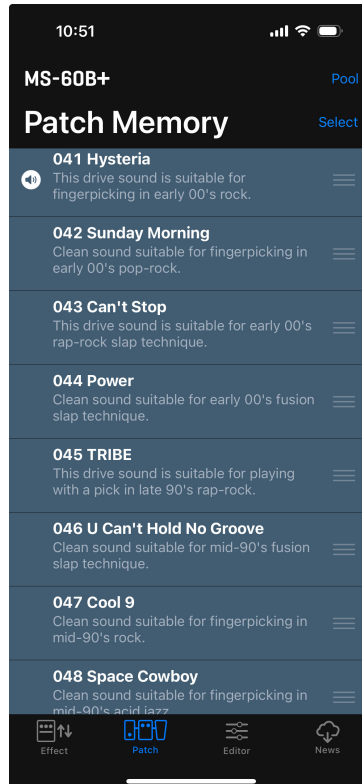

## Patch Memory Screen

View, select and organize patch memories on the device, create backups, import and share patch memories from friends.

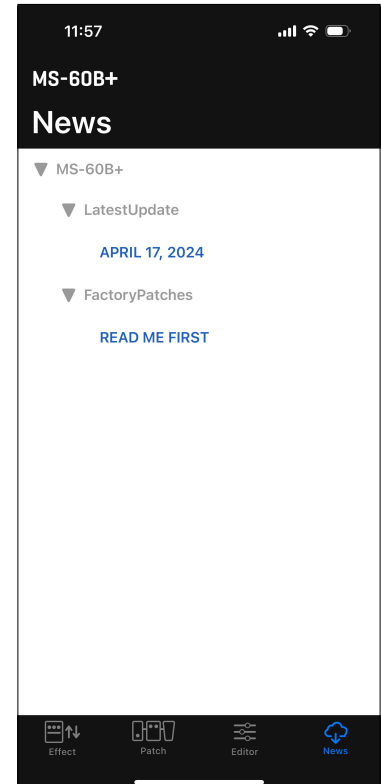

## News Screen

View and download the latest patch memory updates for your device from ZOOM.

## Editor Screen

Choose from hundreds of effects and amps to create and edit patch memories. Bypass, Re-order, change, delete effects and adjust individual parameters to create your custom tones. Save your favorite effect combos to the clipboard to quickly recall them later.

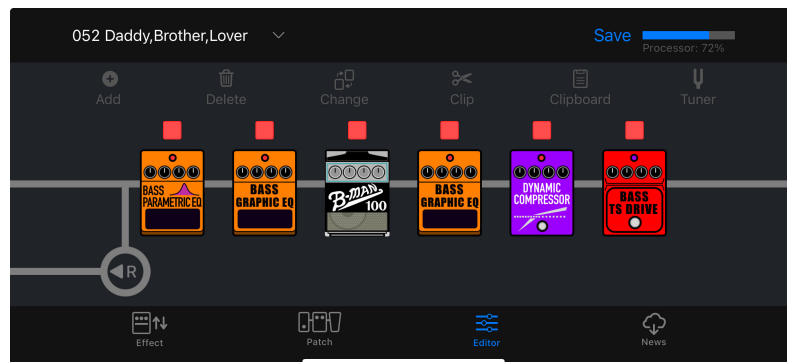

# Using the Effects Screen to manage effects



## Effects Screen Overview



① **MS-60B+** Connected Device

② **Used Memory: 80%** Used memory indicator

③ **Effect Pool** <sup>9</sup>

### Effect Pool / New Effect Indicator

If there are new effects, the number available will be shown.

④ **Filter Effects button**

⑤ **Sort Effects button**

⑥ **Installed Effect**

Displays effect name, icon, description, power usage, use count. Tap to view full details.

⑦ **Favorite button**

Tap this to set the effect as a favorite. Favorite effects can be shown together using the Sort Effects button.

⑧ **Effect Screen button**

⑨ **Patch Memory Screen button**

⑩ **Editor Screen button**

⑪ **News Screen button**



# Deleting/Restoring Effects

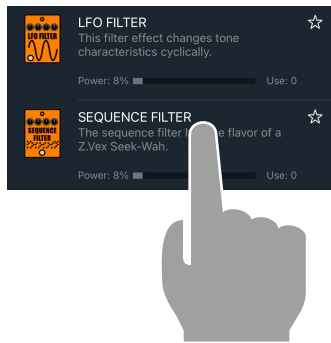

1. Long-tap any effect.

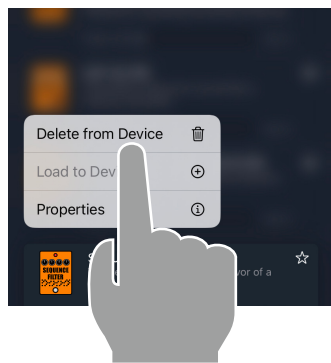

2. Tap "Delete from Device" .

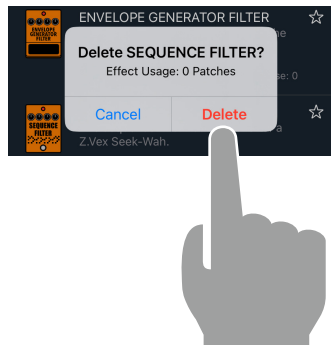

3. Tap "Delete" to confirm.

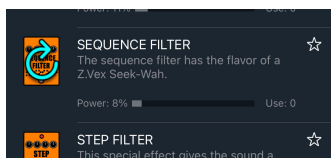

4. The deleted effect displays the restore icon.

**HINT**

- To restore a deleted effect, tap the  icon.

# Sorting Effects

You can select the order in which effects are listed. By default, effects sorted ascending by category.

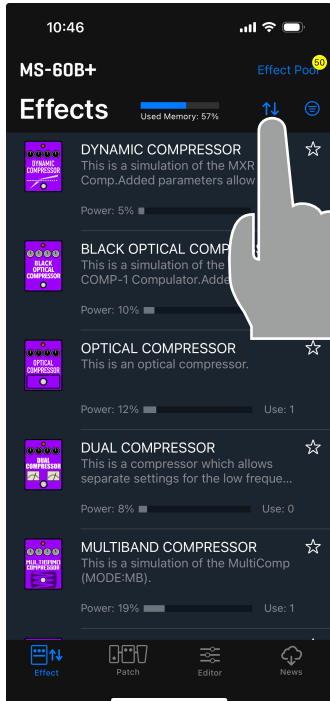

1. Tap the  button open the sort list.

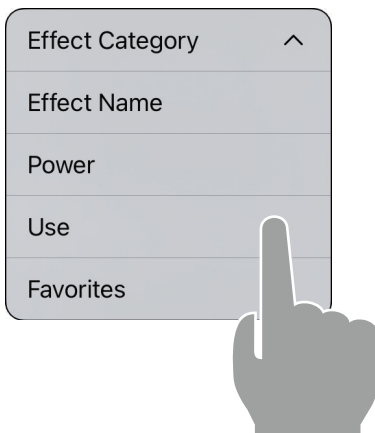

2. Tap the method to sort by.

You can choose to sort ascending " ^ " or descending " v " by tapping the sort method again.

Effect Category	Sort in category order.
Effect Name	Sort in alphabetical order.
Power	Sort by power usage.
Use	Show by the number of times used in patch memories on the device.
Favorites	Sort with favorites first.

# Filtering Effects

By default, the all effects are displayed.

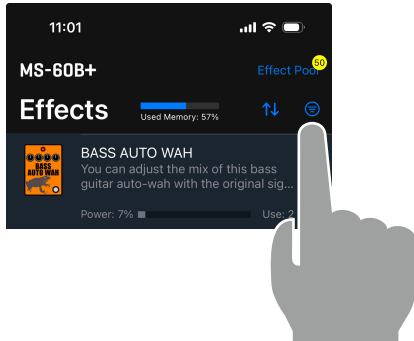

1. Tap the  button.

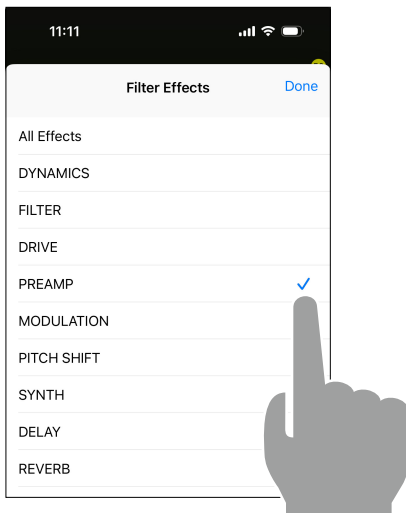

2. Tap the effect category you would like to display. Tap done.

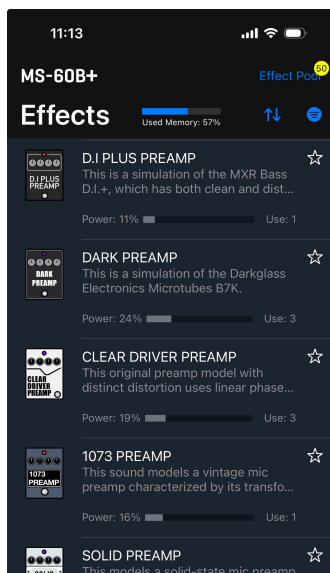

3. The list displays only the effects in the filtered category.

# Viewing Effect Properties

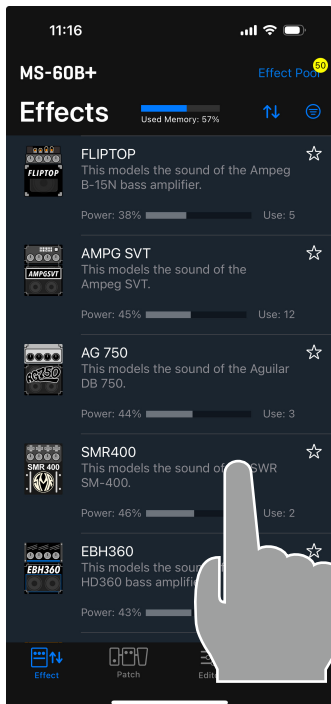

1. Tap any effect row.

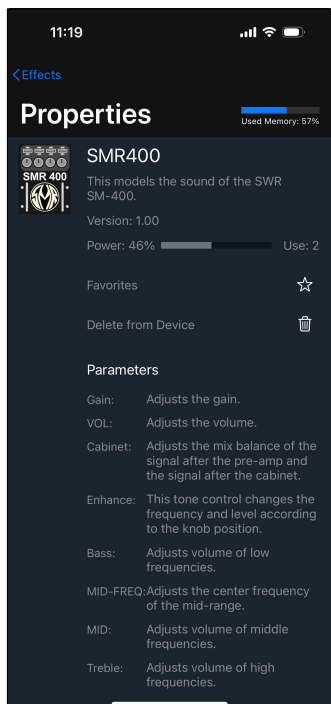

2. The Effect property screen appears.

From this screen you can view the effect name, description, version, power usage, effect count, and descriptions for each parameter of the effect.

You can also add/remove to/from favorites or delete/restore the effect.

# Using the Patch Memory Screen to manage patch memories



## Patch Memory Screen Overview

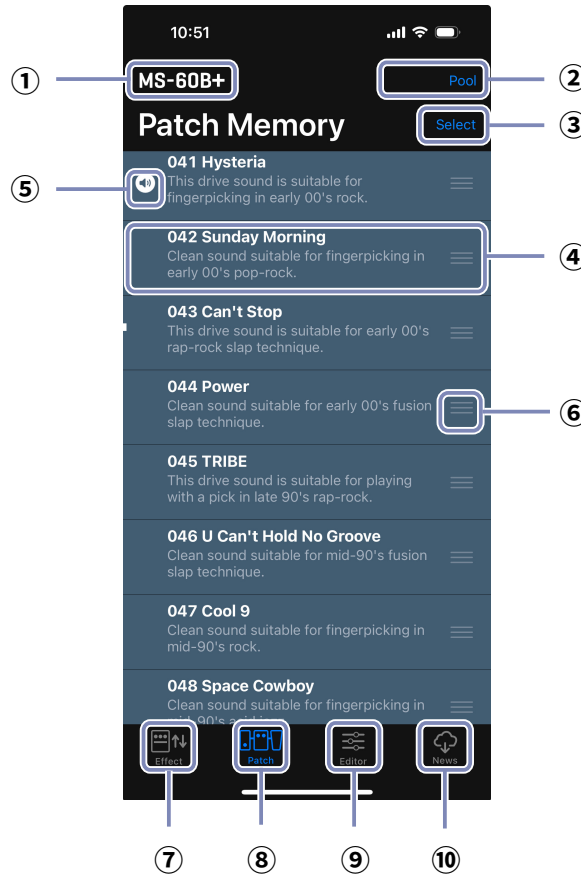

① **MS-60B+** Connected Device

② **Pool** Pool button

③ **Select** Select mode button

④ **Patch memory Entry**

Displays the patch memory number, name, description. Long tap to view and edit details.

⑤ **Current patch indicator**

the patch that is actively playing on the device.

⑥ **☰** Patch Memory Reorder icon

⑦ **Effect** Effect Screen button

⑧ **Patch** Patch Memory Screen button

⑨ **Editor** Editor Screen button

⑩ **News** News Screen button

# Reordering a Patch Memory

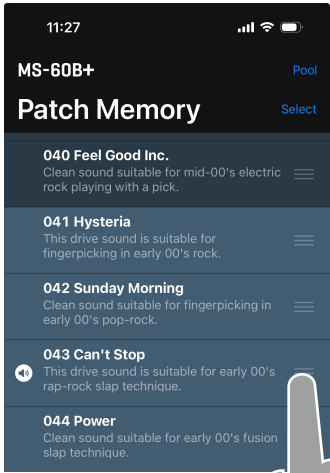

1. Tap and hold the  on the patch memory you want to move.

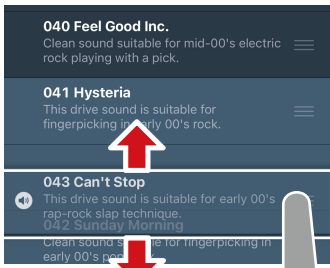

2. Drag the patch memory up or down in the list to reorder it.

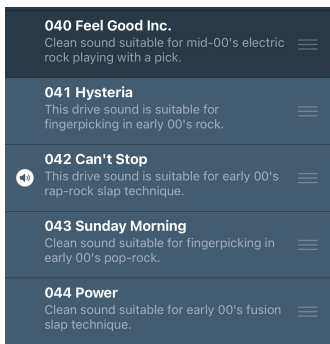

3. Release the tap to place the patch memory in the new location.

## Editing Patch Memory Names and Comments

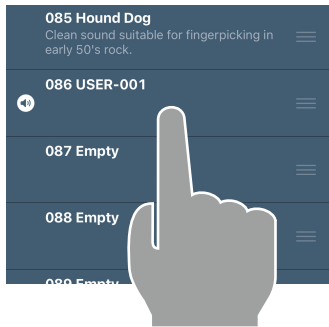

**1. Long-tap any patch memory on the Patch screen.**

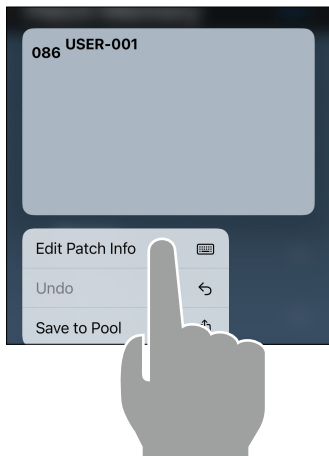

**2. Tap "Edit Patch Info " to display the on-screen keyboard for editing.**

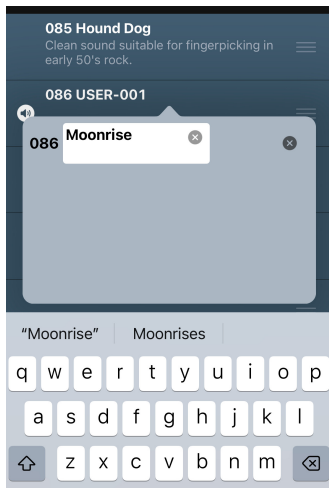

**3. Tap the name or comment fields to edit them.**

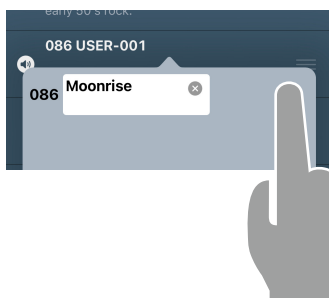

**4. Tap  to finish editing.**

### NOTE

- Valid characters and symbols: ! % & ' + , - . = \_ (space) A - Z, a - z, 0 - 9.
- Patch memory names can have a maximum of 28 characters.

# Backing Up a Single Patch Memory

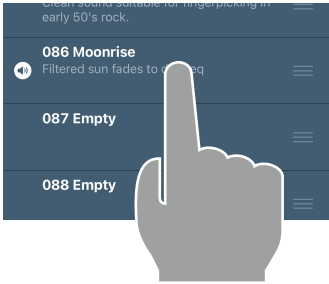

1. Long-tap any patch memory to back up.

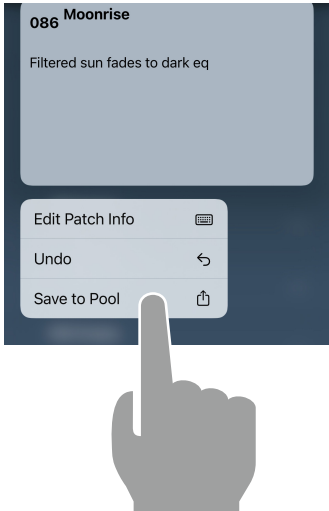

2. Tap "Save to Pool" .

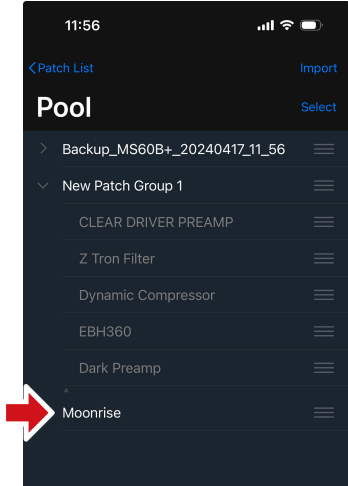

3. The patch memory is added to the Pool.



# Backing Up Multiple Patch Memories

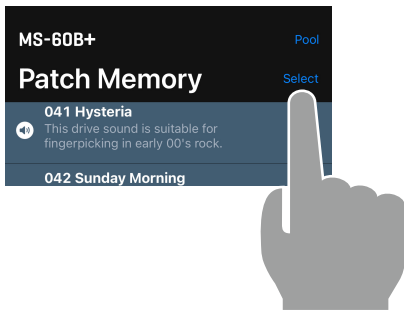

1. Tap **Select** on the Patch Memory screen.

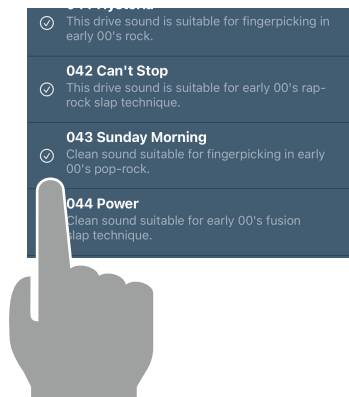

2. Tap one or more  to select them.

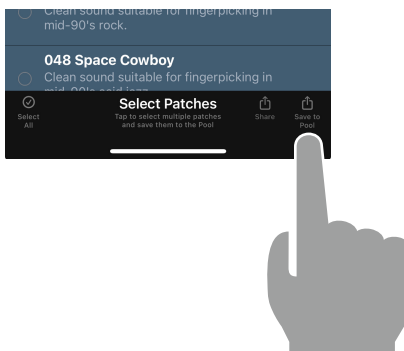

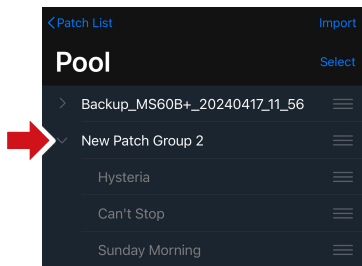

3. Tap  to save selected patch memories to the Pool.



4. Selected patch memories are saved to a Patch Group (folder) and added to the Pool.

## HINT

• Tap  then  to create a backup of all the patch memories on the device.

# Restoring backed up patch memories to the unit

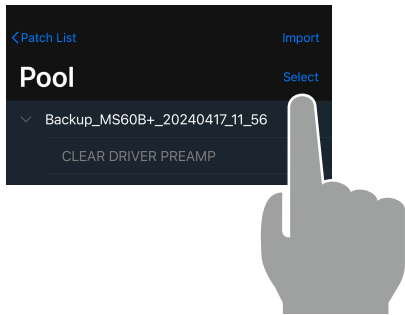

1. Tap "Select" on the Pool screen.

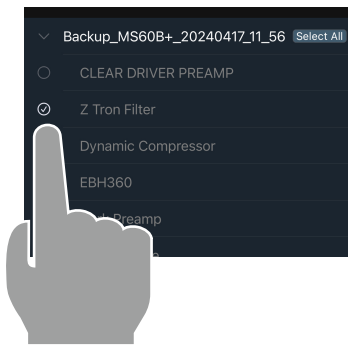

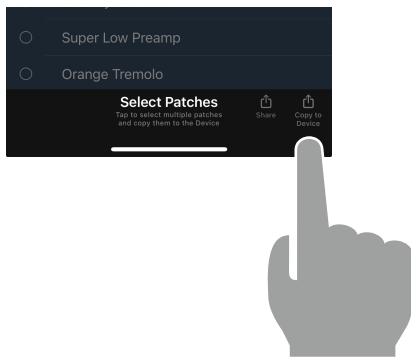

2. Tap one or more  to select them.

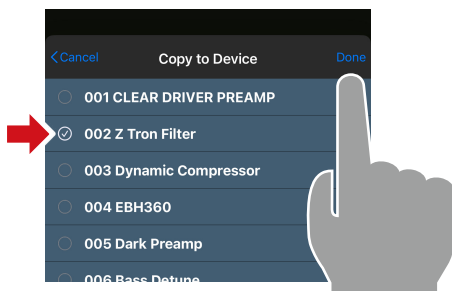

3. Tap  to save selected patch memories to the Patch Pool.



4. Tap  on the Copy to Device screen to select the destination of the first patch memory. Tap .

## NOTE

- Tap  to select every patch memory in the folder.

# Restoring a Back Up to the Device

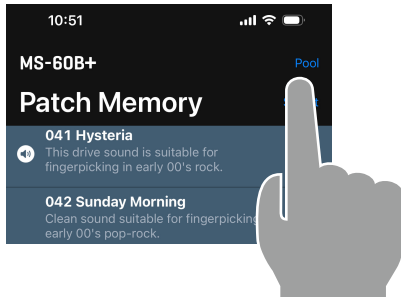

**1.** Tap "Pool" on the Patch Memory screen.

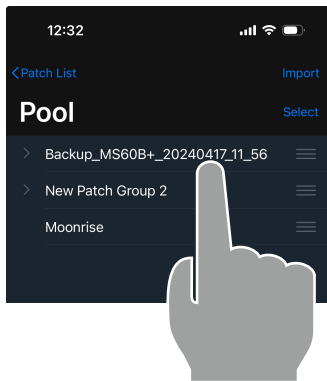

**2.** Long-tap a back up folder.

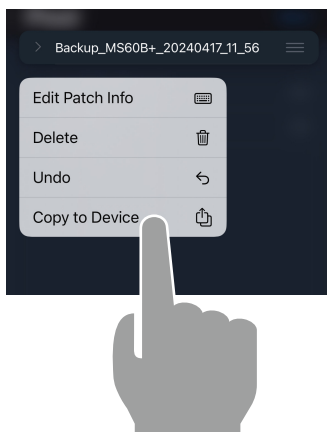

**3.** Tap "Copy to Device". The back up has been restored to the device.

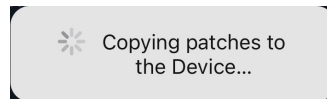

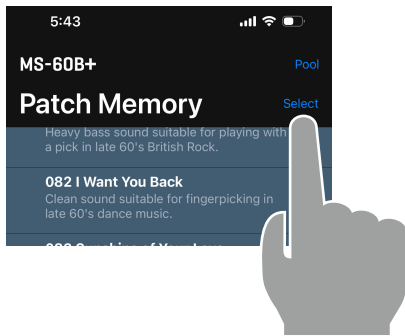

The message disappears after restoring completes.

# Sharing a Patch Memory

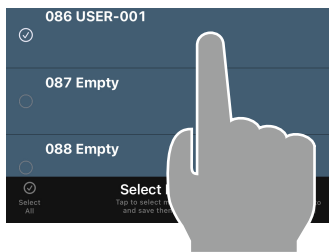

1. Tap **Select** on the Patch Memory screen.



2. Tap one or more  to select the patch memories you wish to share.

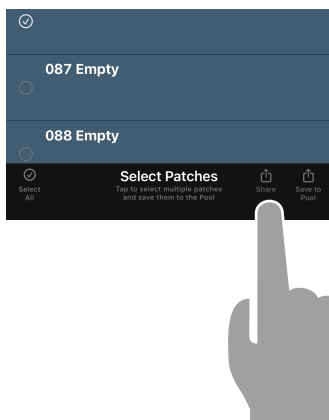

3. Tap the  button to open the device sharing screen.

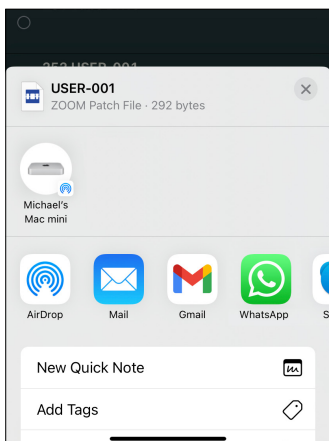

4. From the mobile device sharing screen, choose how you want to share the patch memory file.

## Importing a Patch Memory

Patch memory files can be imported from iPhone.

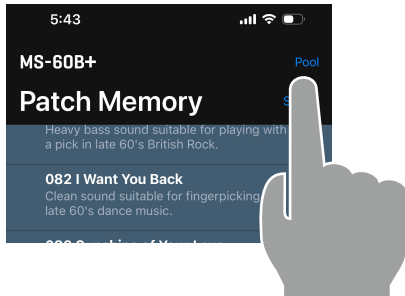

1. Tap **Pool** on the Patch Memory screen.

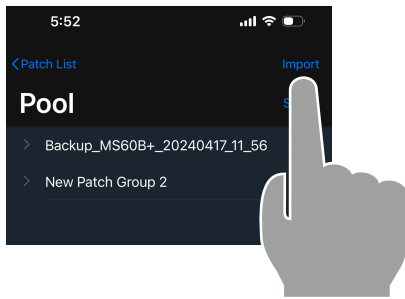

2. Tap the **Import** button.

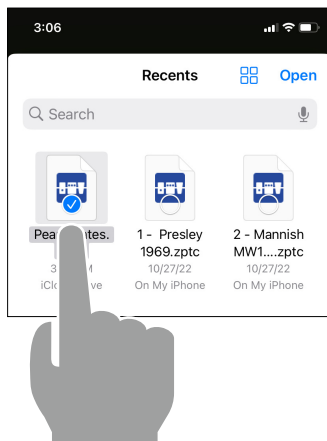

3. Tap to select the patch memory files (.zptc) that you want to import.

Tap Open.

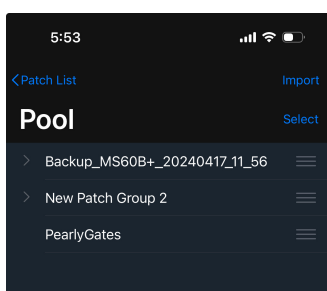

4. The imported patch memories appear in the Pool.

# Using the Editor Screen to edit patch memories



## Editor Screen Overview

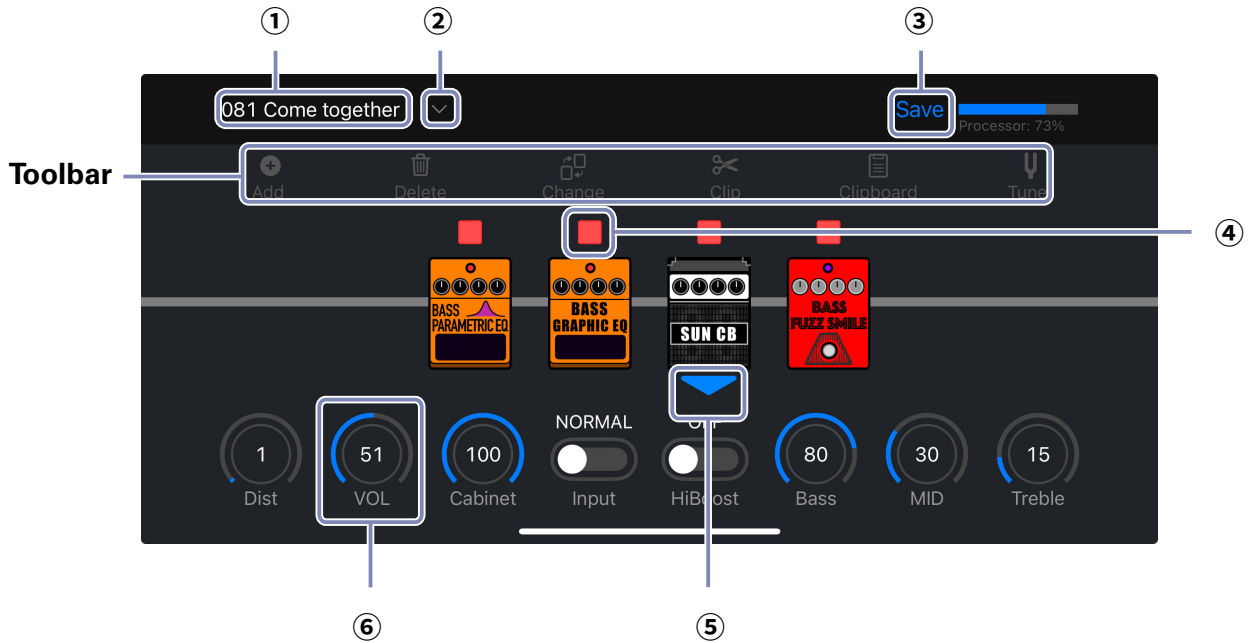

### ■ Toolbar

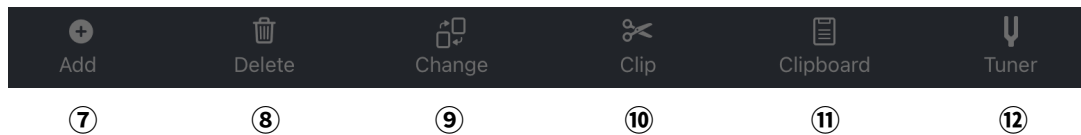

① **022 Ambient** Current patch memory

② **▼** Patch memory select button

③ **Save** Save patch memory button

④ **■** Effect on/off button

⑤ **▼** Current effect indicator  
shows which effect parameters are displayed.

⑥ **100 Bass** Effect parameter knob

⑦ **+** Add effect button

⑧ **🗑️** Delete effect button

⑨ **🔄** Change effect button

⑩ **✂️** Clip tool button

⑪ **📄** Clipboard button

⑫ **🎵** Tuner button

## Selecting a Patch Memory for Editing

1. Tap the  button on the navigation bar.

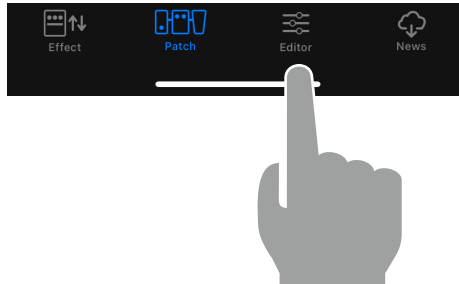

2. Tap . The current patch memory is displayed to its left.



3. Tap the patch memory you want to edit.

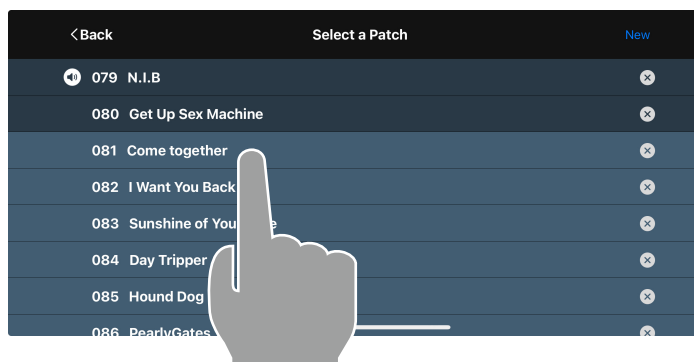

### HINT

- Tap the  button to create a blank patch memory.

## Editing a Patch Memory Name

1. Tap the patch memory name in the Editor.

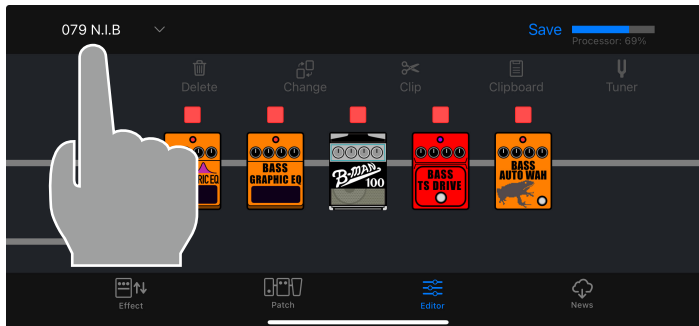

2. The on-screen keyboard appears. Edit the name.

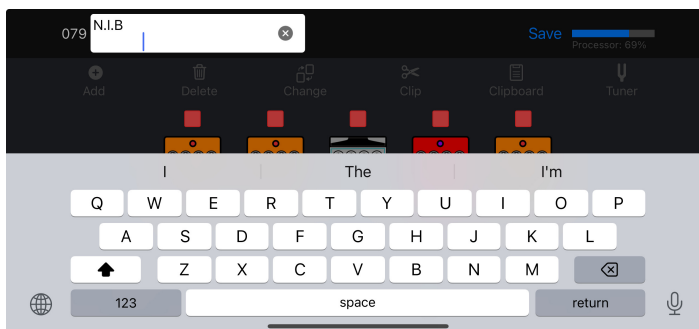

3. When done, tap outside the field to finish editing.

### NOTE

- Valid characters and symbols: ! % & ' + , - . = \_ (space) A - Z, a - z, 0 - 9.
- Patch memory names can have a maximum of 28 characters.



## Turning effects on/off

1. Touch the indicator above an effect to turn it on/off.

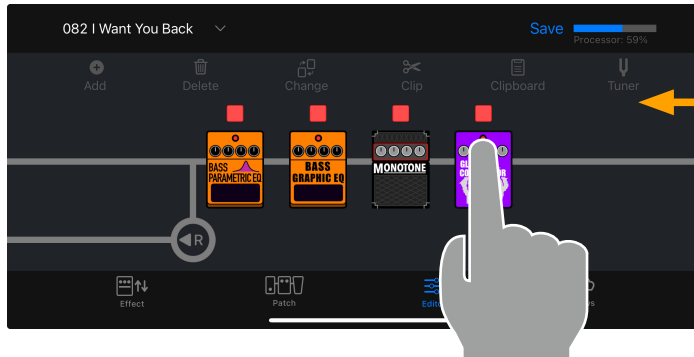

Make sure none of the tools are selected.

When on, it lights red. When off, it is unlit.

# Adjusting Effect Parameters

1. Tap an effect to show/hide its parameters.

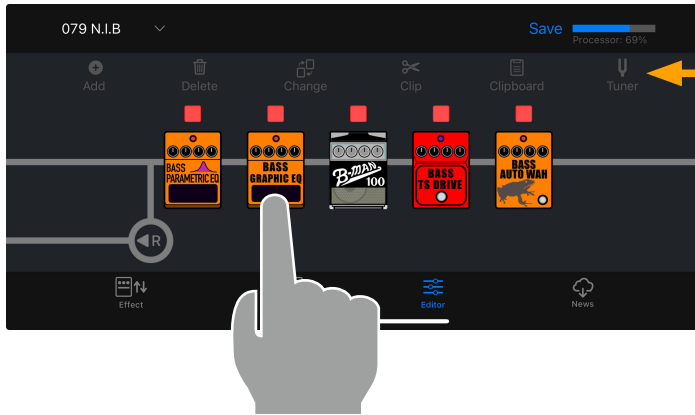

Make sure none of the tools are selected.

2. Tap and swipe right/left to change values.

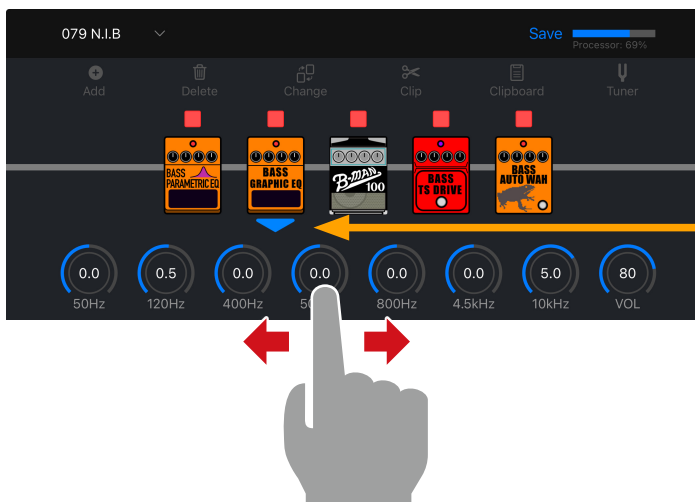

The  shows which effect is being edited.

3. For precise parameter changes, double-tap a parameter knob to display the parameter popup.

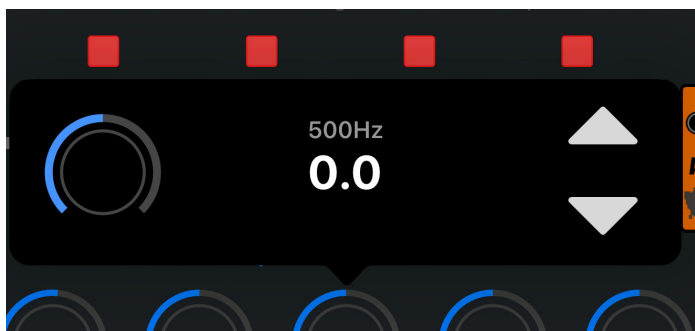

# Changing Effects

1. Tap the  button in the toolbar.

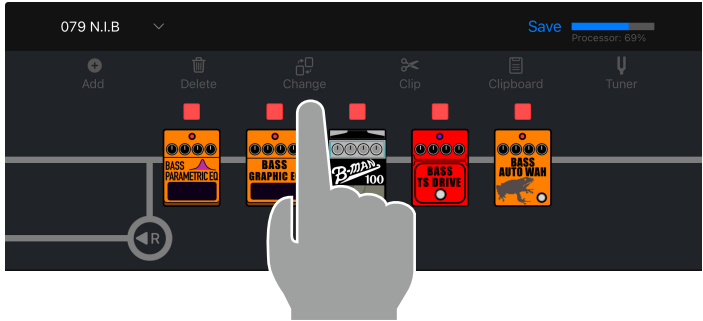

2. Tap the effect you wish to change.

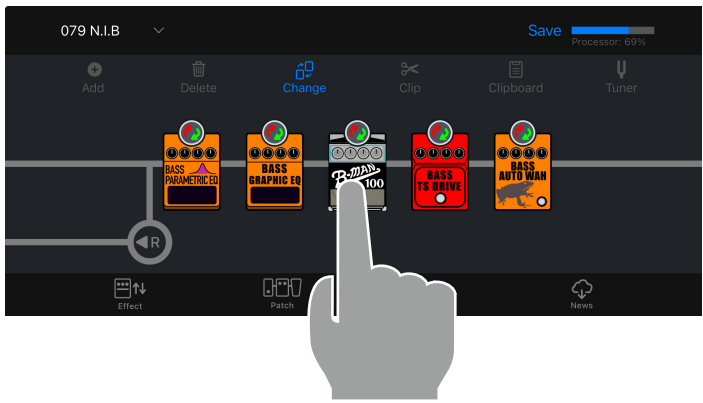

3. Select a different effect from the effect type list. Then tap "OK".

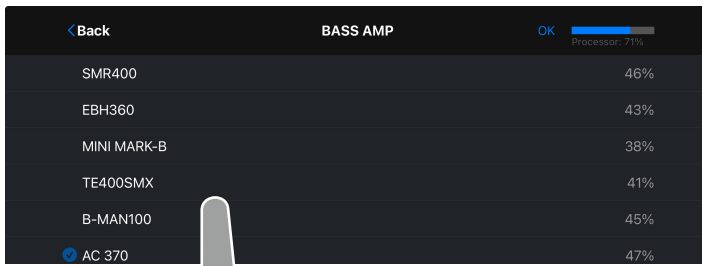

Tap the  button to select effects from other effect categories.

4. The original effect is replaced with the new effect.



Tap  to finish replacing effects.

# Adding Effects

1. Tap the  button in the toolbar.

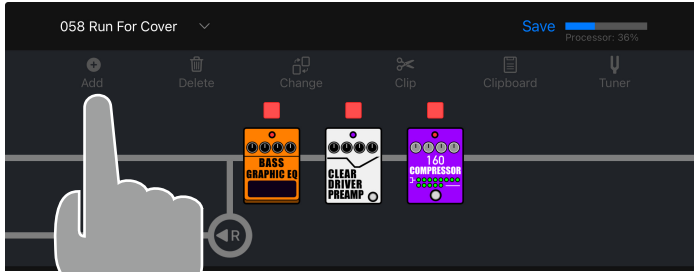

2. Touch  and drag it to the position where you want to add an effect. Then, tap .

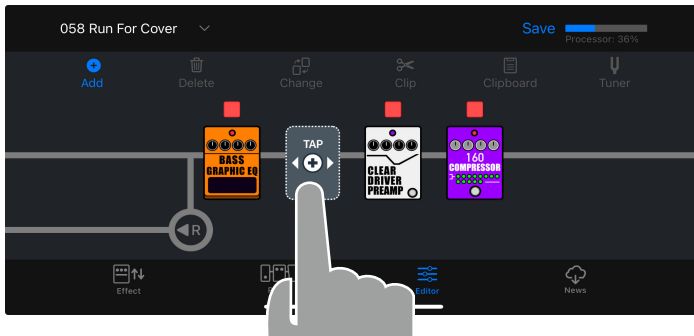

3. Touch the category of the effect that you want to add.

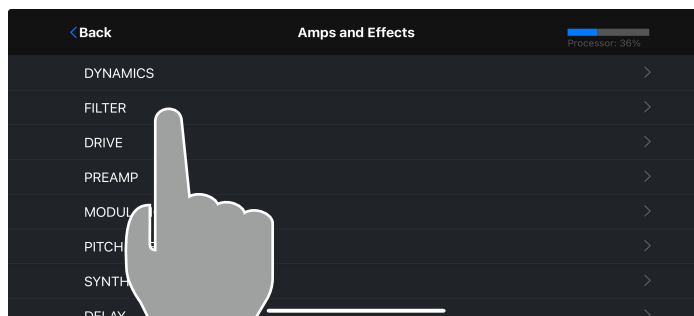

4. Select the effect that you want to add from the effect type list and tap "OK".

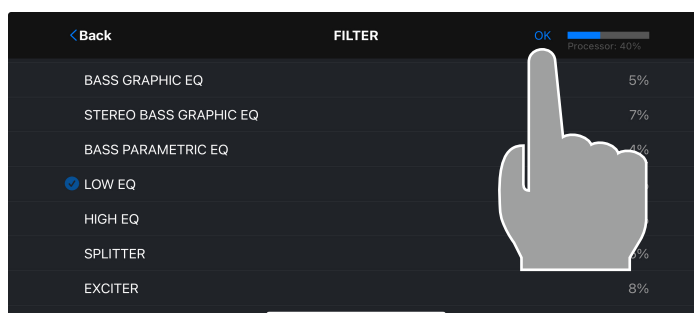

# Deleting Effects

1. Tap the  button in the toolbar.

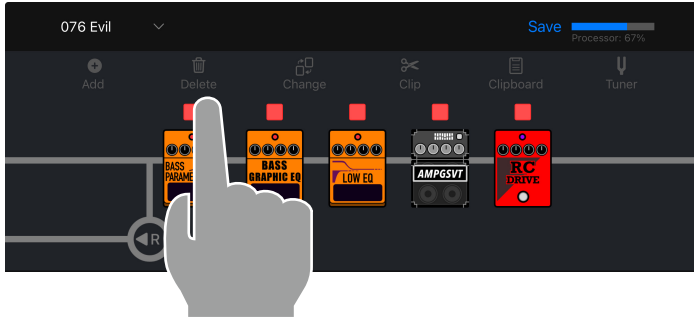

2. Tap the effect you wish to delete.

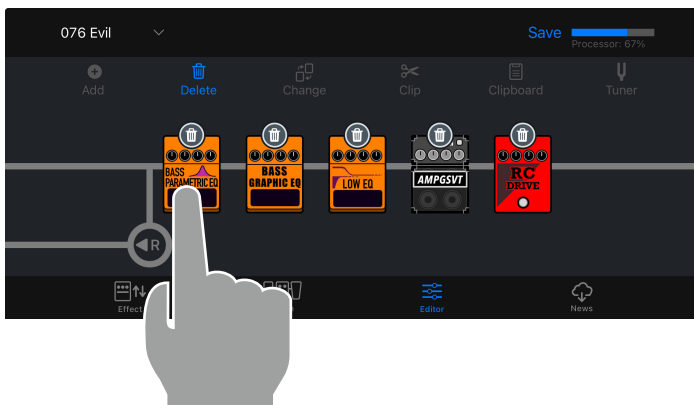

3. Delete the effect.

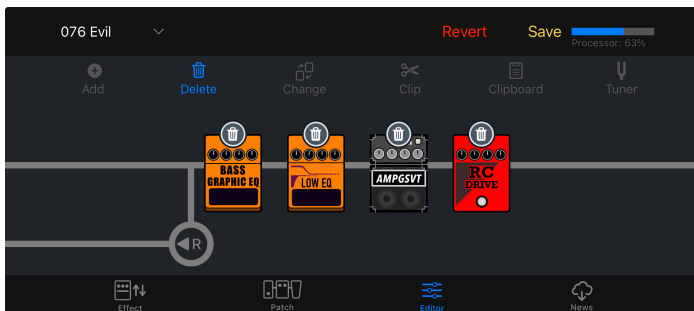

Tap  to finish deleting effects.

## Reordering Effects

You can drag and drop to re-order the effects in the effect chain, at any time, except when the editor is in delete or clip mode.

### 1. Tap and hold the effect you want to move.

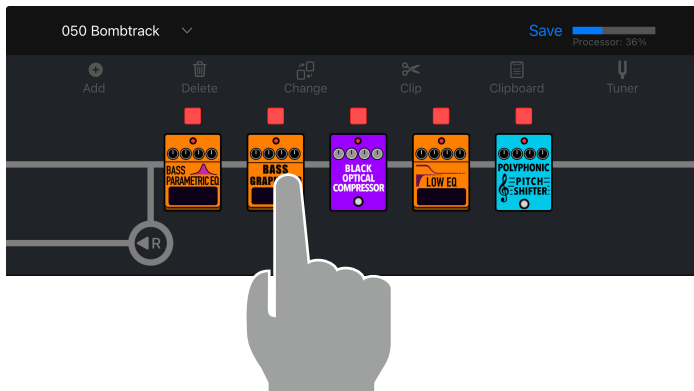

### 2. Drag the effect right or left along the chain to re-order it.

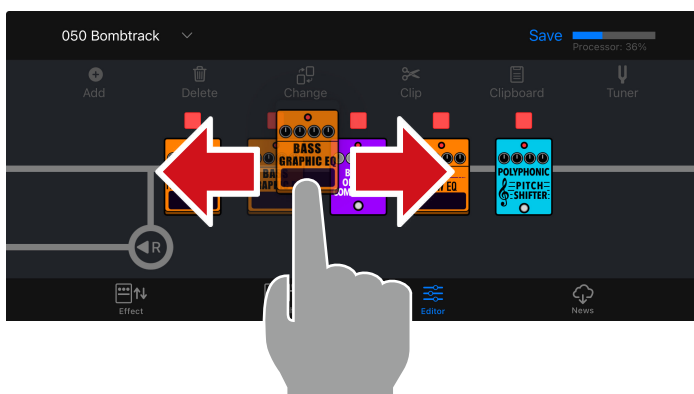

### 3. Release to drop the effect in the desired location.

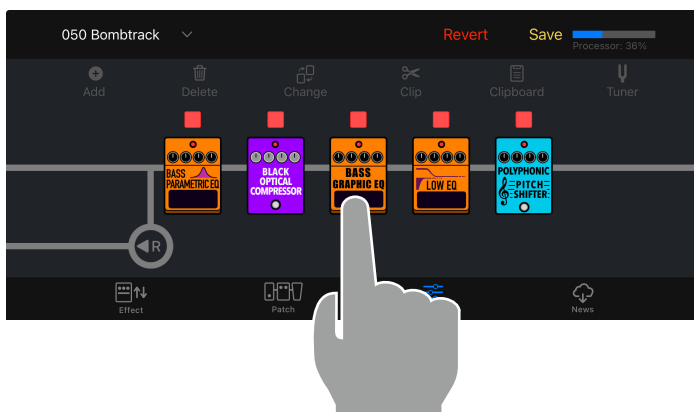

# Adjusting Tempo

## 1. Add a BPM module.

The BPM module is in the SFX category (→ [Adding effects](#)).

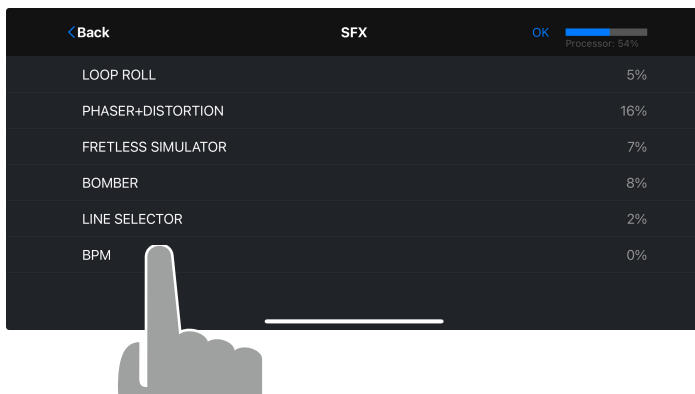

## 2. Tap the BPM Module in the chain.

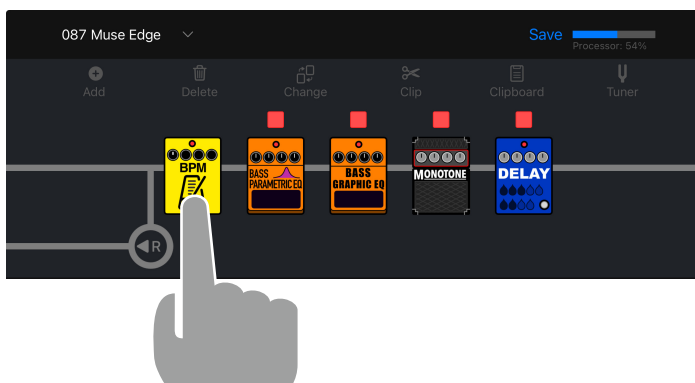

## 3. The tempo pop up appears where you can tap the tempo or adjust it.

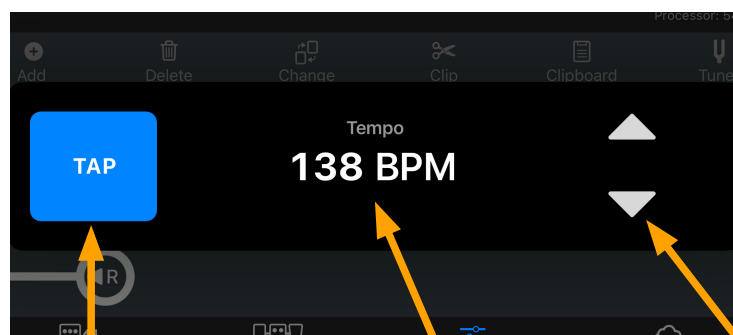

Tap rhythmically in time to set the tempo to your tap interval

Current Tempo

Tap up/down arrows to increase or decrease tempo by 1

### HINT

- Each patch memory can only have one BPM module.

# Changing the R signal output position

1. Press and hold .

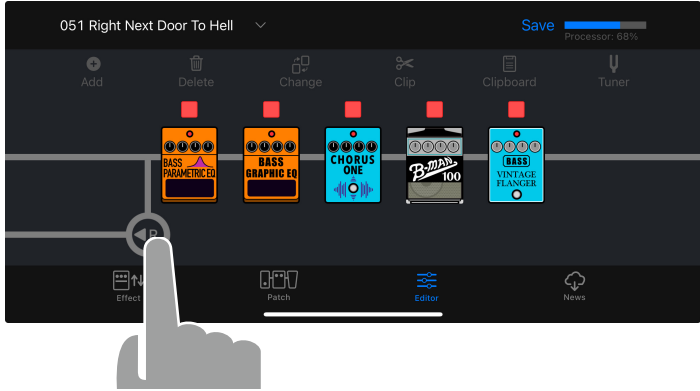

2. Drag left or right to change its position.



3. Stop pressing at the desired position to confirm the change.

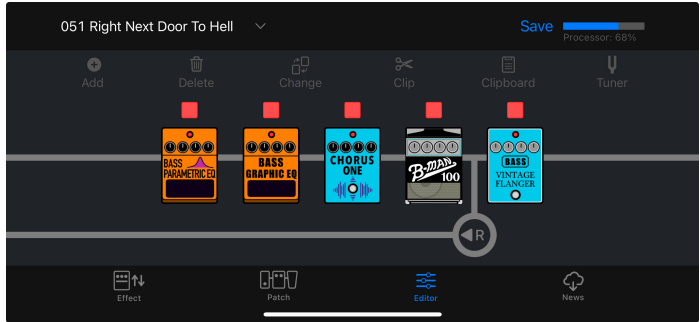



# Saving a Patch Memory

1. Tap the **Save** button at the top of the Editor screen.

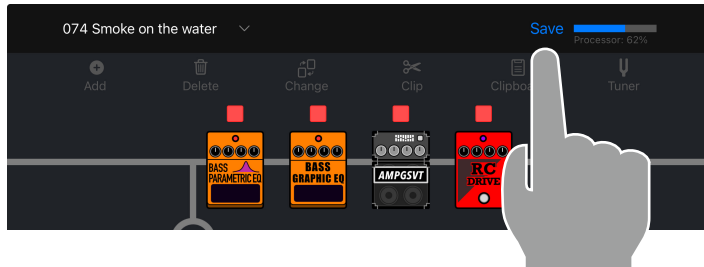

2. Tap the  to select the patch memory you want to overwrite. Tap "OK".

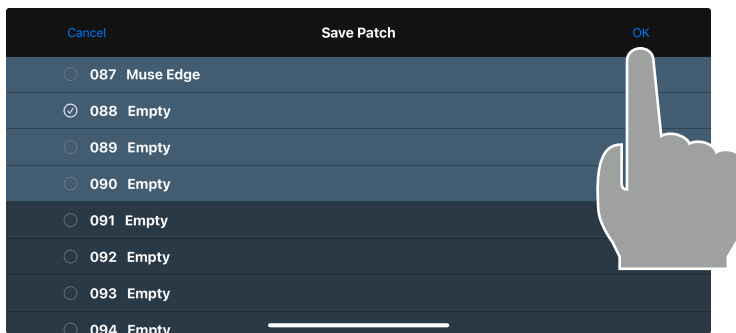

3. The confirmation popup is displayed. Tap Cancel or Save.

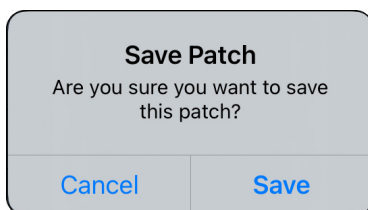

## NOTE



- If the Save button is yellow, the file has been changed.
- When autosave is enabled on your device, any edits are automatically saved when you navigate to a different screen. You can also tap "Save" at any time whether the hardware's autosave feature is enabled or not.

## Reverting a Change

If you want to discard the changes you made to the patch memory, you can use the Revert function.

1. After you make a change, the **Revert** button appears in the toolbar. Tap it to discard your changes.

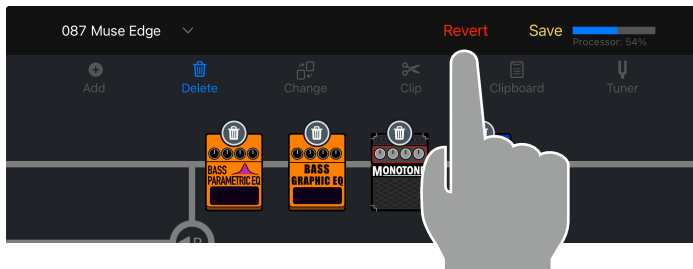

2. Tap Previous to discard your changes.

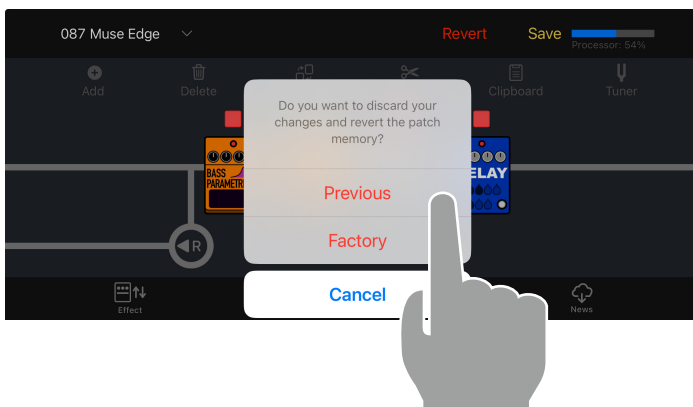

3. The patch memory returns to the previous state.

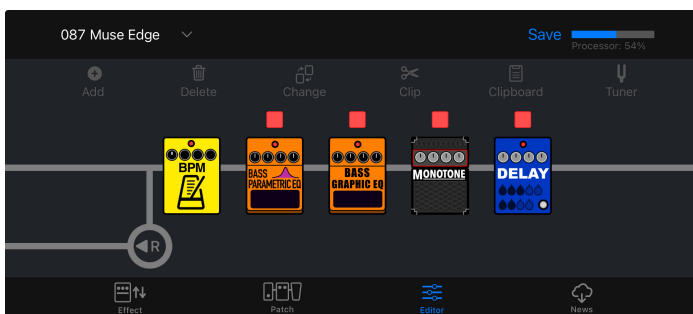

### NOTE

- If you tap "Factory", the original factory patch memory for that patch memory number will be restored.

## Using combinations of favorite effects (clips)

### ■ Creating Clips

A "Clip" is a frequently used combination of 1 - 4 effect units and their settings. You can create your own clips, store them on the Clipboard, and use them to quickly build new patch memories.

1. Tap the  button in the toolbar.

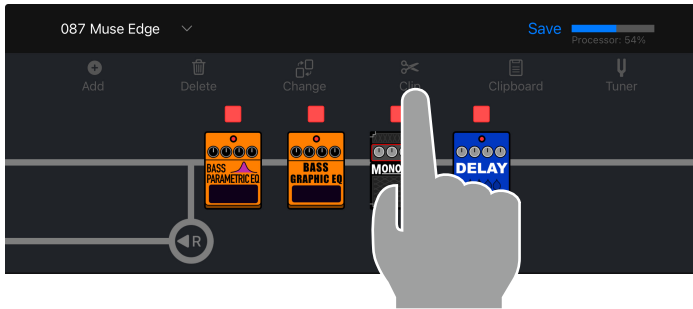

2. Tap to select up 4 effect units to add to your clip.

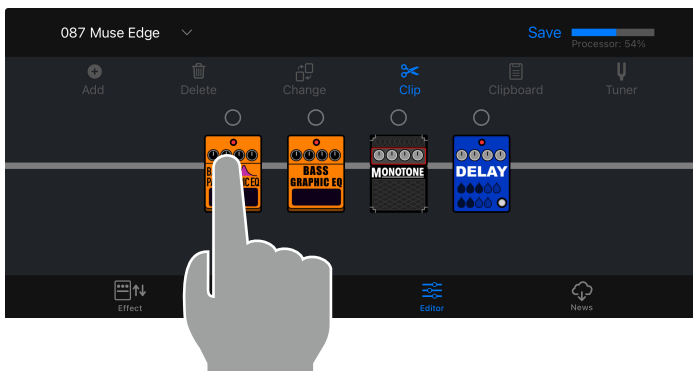

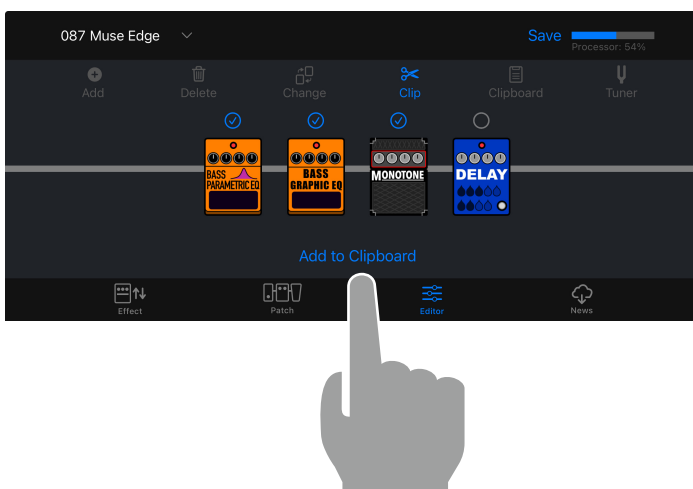

3. Tap the  button. The clip is added to the Clipboard.

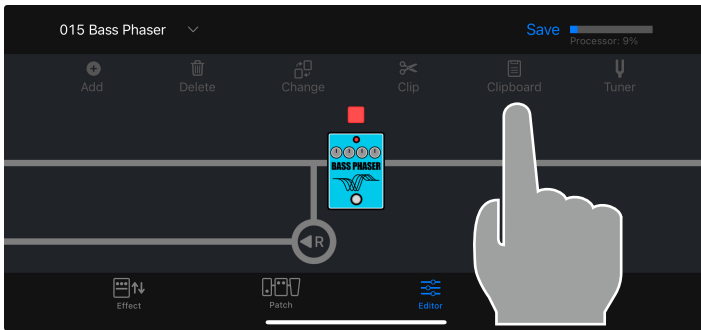

## ■ Adding a Clip to a Patch Memory

A "Clip" is a frequently used combination of 1 - 4 effects and their settings, that you can use to quickly build new patch memories.



1. Tap  in the toolbar. The clips will appear below the effect chain.

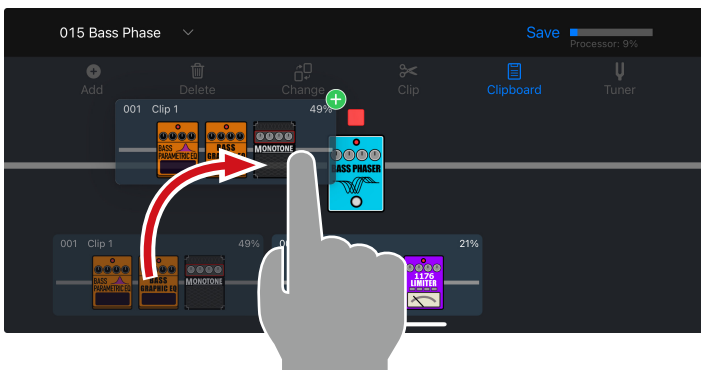

2. Tap-hold then drag clip onto the effect chain.

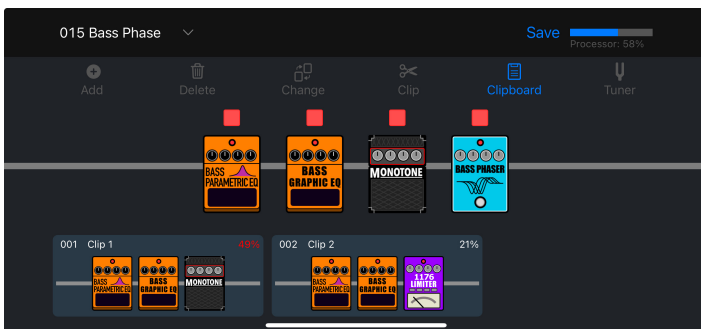

3. Release to drop the clip when it is in the desired position. The effects from the clip are added to the patch memory.

### NOTE



- Each clip displays its processor usage. If adding the clip to the patch memory will cause the processor to exceed 100%, the number will be displayed in red and the clip cannot be added to the patch memory.

## ■ Editing Clip Names

1. In Clipboard mode, long-tap a clip.



2. Tap "Edit Name" .

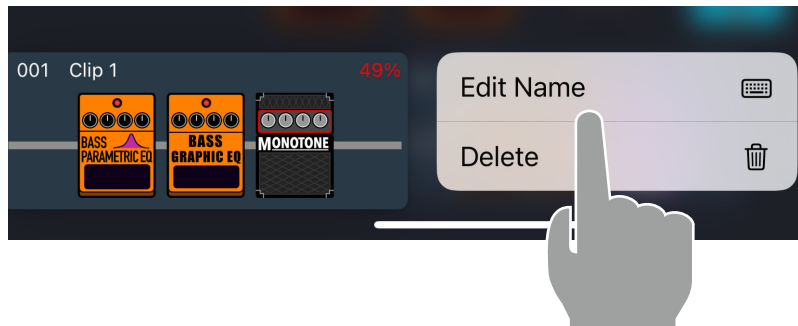

3. Edit the name using the on-screen keyboard. Tap return or  on the screen when you are finished editing.



## ■ Deleting a Clip

1. In Clipboard mode, long-tap a clip.



2. Tap "Delete 🗑️".

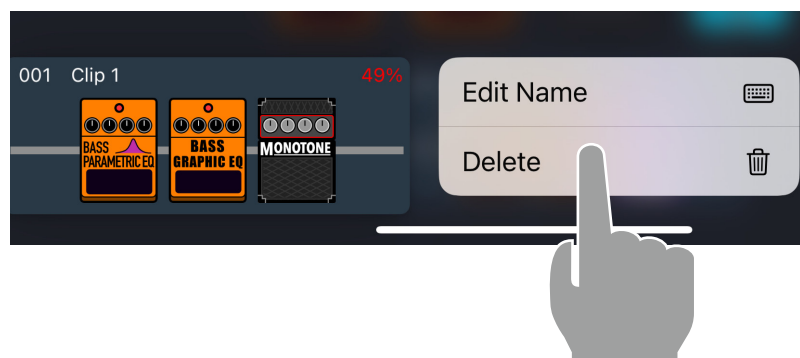

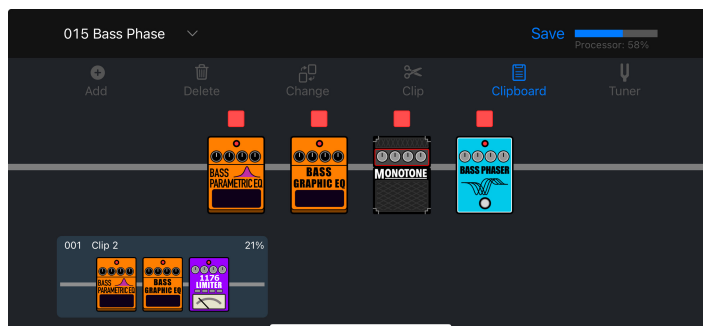

3. The Clip is removed from the Clipboard.

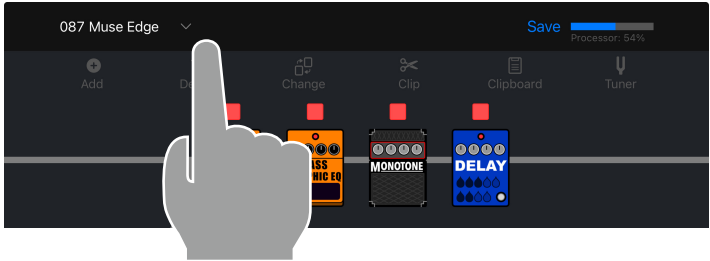

# Creating a New Patch Memory

1. Tap the  button at the top of the Editor screen.



2. Tap the  button at the top of the Select a Patch screen. The app creates a new patch memory.

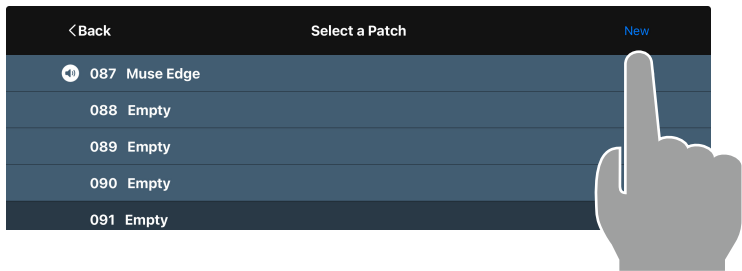

3. Tap the  button.

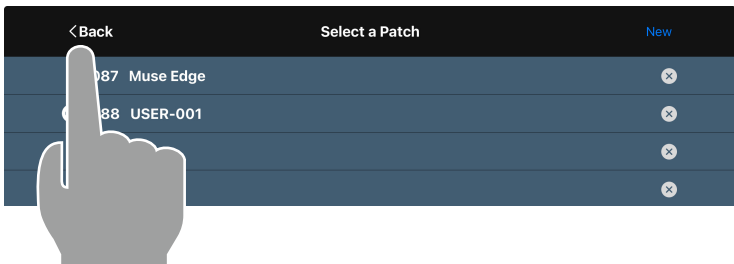

4. Edit the new patch memory in the editor.

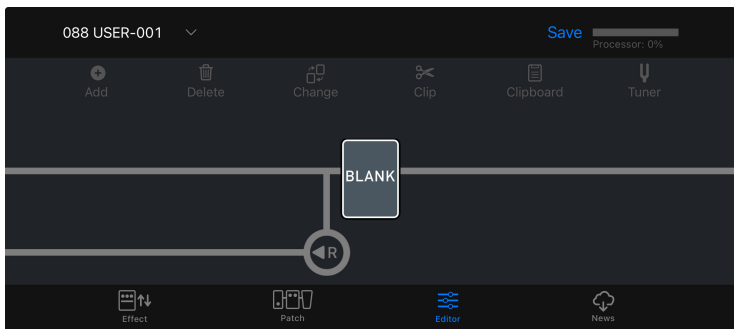

## Erasing a Patch Memory

1. Tap the  button at the top of the Editor screen.

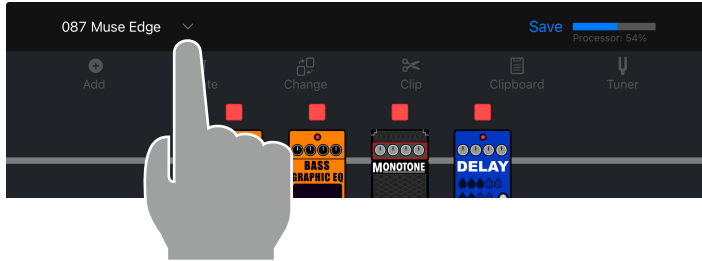

2. Tap the  button to erase the patch memory.

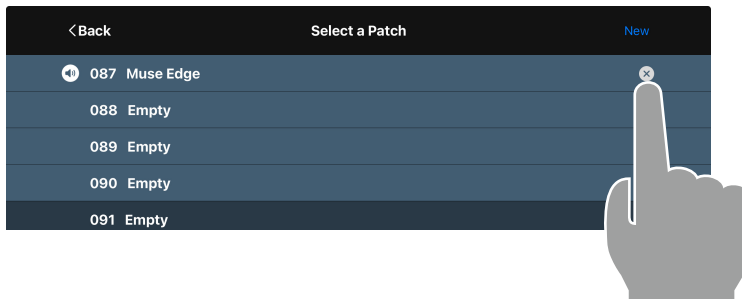

3. Tap "Yes" to confirm or "No" to cancel the operation.

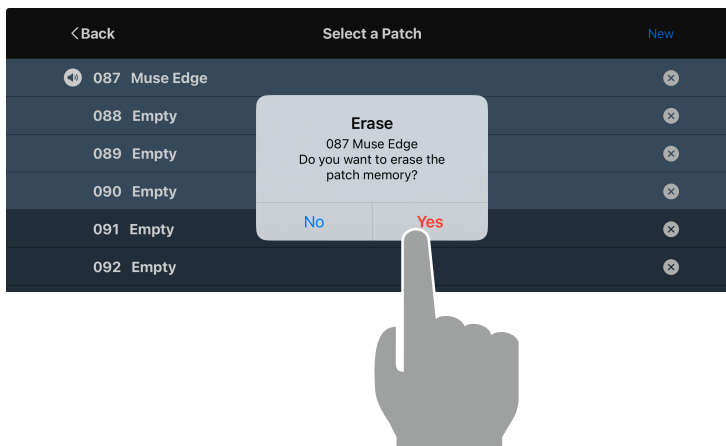

4. The erased patch memory retains its patch memory number and is named "Empty".





---

# Tuning Your Instrument

---

1. Tap the  button in the navigation bar.

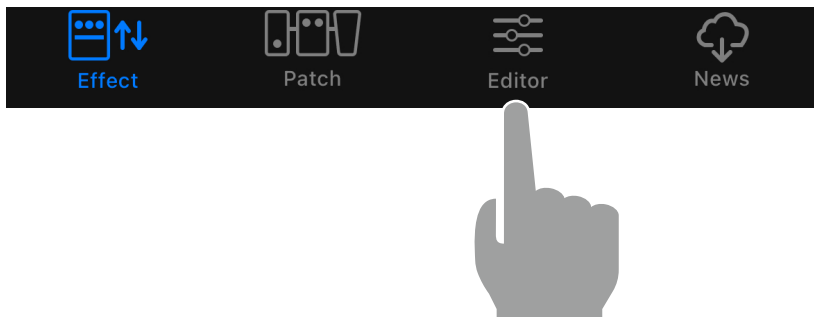

2. Tap the  button in the toolbar.

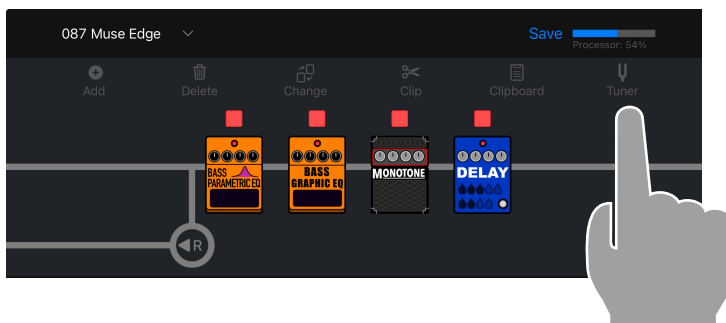

3. The Tuner pop up appears where you can tune your instrument.

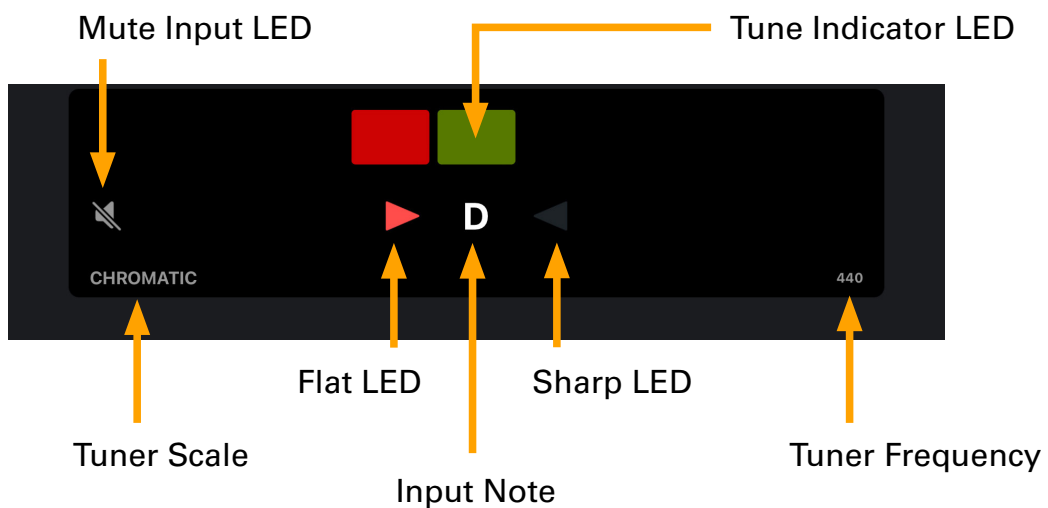

# Using the News Screen to review updated information



## News Screen Overview

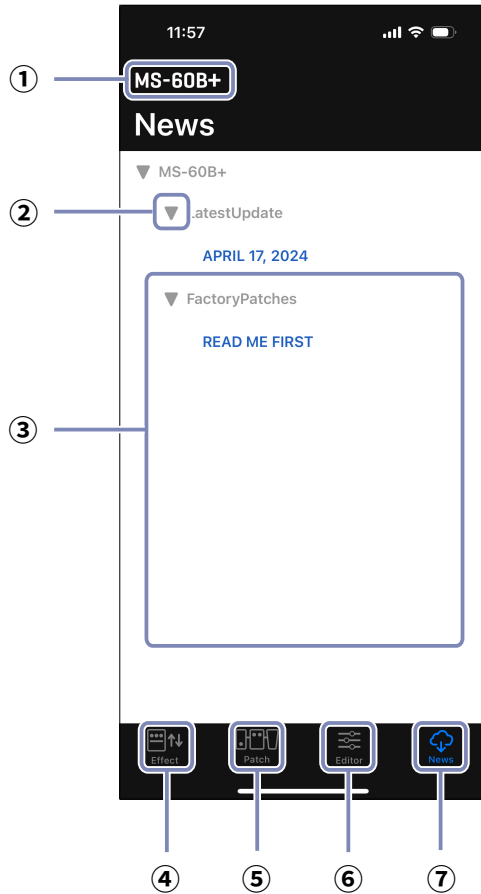

① **MS-60B+** Connected Device

② Open - close button

③ **Patch Memory Updates**

Tap this to view the contents. This shows information, including the availability of effects and patch memories.

④ **Effect Screen button**

⑤ **Patch Memory Screen button**

⑥ **Editor Screen button**

⑦ **News Screen button**

# Select and View News Updates

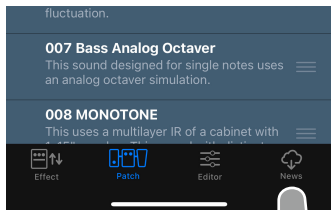

1. Tap the  button in the navigation bar.

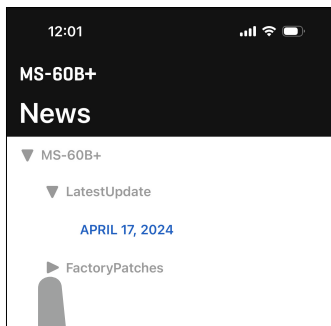

2. Tap the  button to show the category contents.

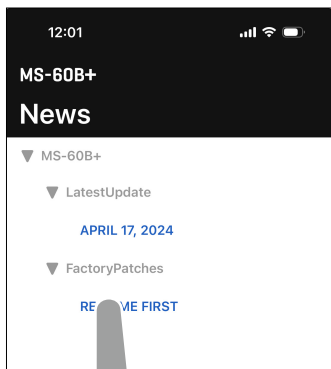

3. Tap a news item to view it.

# Download Patch Memory Updates



**1.** From the News screen, tap a news item to view it.

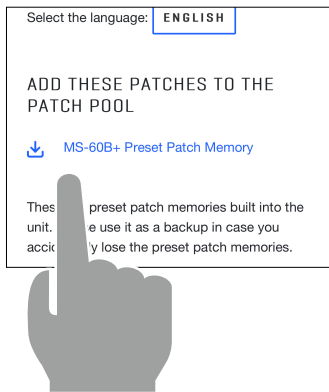

**2.** Tap the "Download" button to download the patch memories.

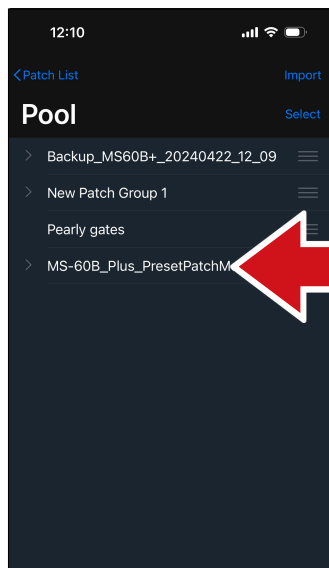

**3.** The patch memories are downloaded, extracted and saved into a Patch Group in the Pool.

# Loading effects that are newly available into the unit

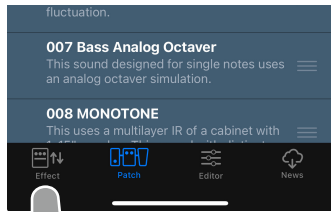

1. Tap the  button in the navigation bar.

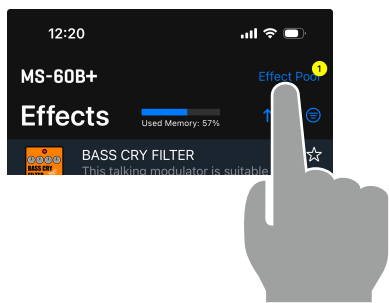

2. Tap the **Effect Pool** button. The **Effect Pool** appears.

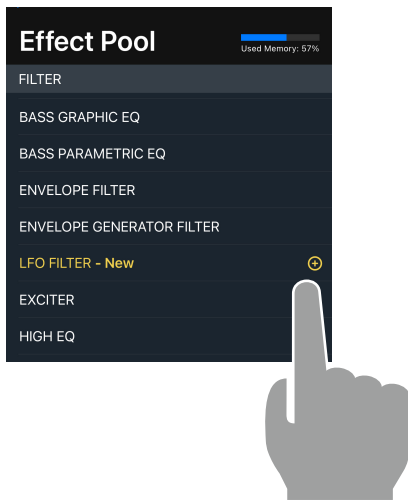

3. Tap the  next to the effect you want to load.

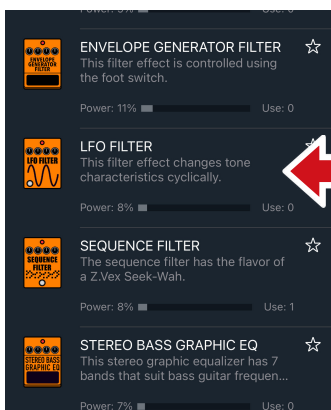

4. The effect is loaded onto the device and displayed in the **Effects** list.

## NOTE

- **New** - An effect that has been downloaded from ZOOM but is new to the device.



ZOOM CORPORATION

4-4-3 Kanda-surugadai, Chiyoda-ku, Tokyo 101-0062 Japan  
[zoomcorp.com](http://zoomcorp.com)

Z2I-5269-01